

REVISION RECORD

REV	ECN	DESCRIPTION	DRFT	DATE
-----	-----	-------------	------	------

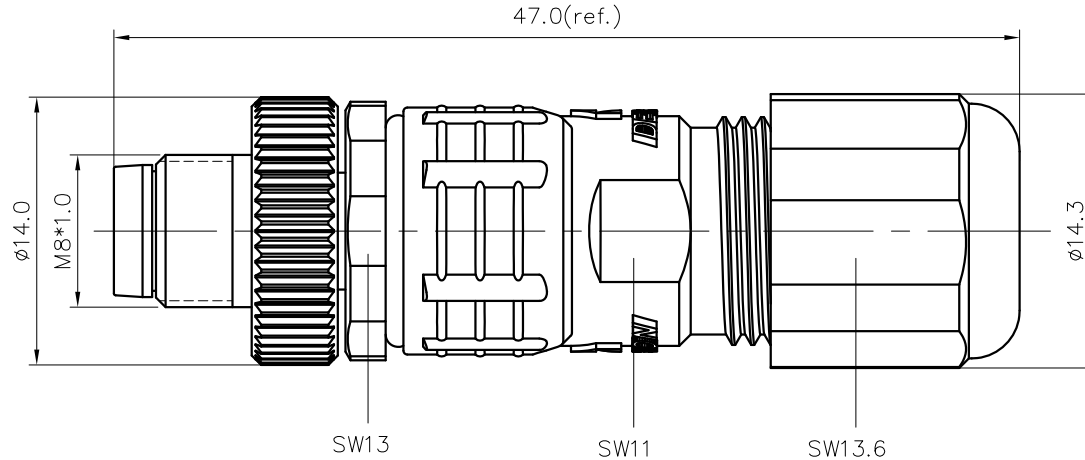
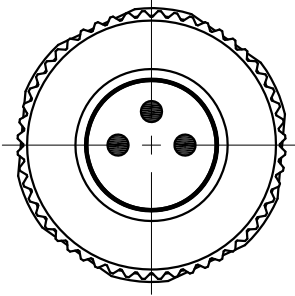

NOTES:

- Rated voltage/current : 3pin: 60V / 3A
4pin: 60V / 3A
5pin: 30V / 3A
6pin: 30V / 1.5A
8pin: 30V / 1.5A
- Withstanding voltage : 3,4pin: AC850V/1Min
5,6,8pin: AC650V/1Min
- Levels of protection: IP67
- Wire range : 3pin: 24~22AWG/0.25~0.34mm²
4pin: 24~22AWG/0.25~0.34mm²
5pin: 24~22AWG/0.25~0.34mm²
6pin: 26~24AWG/0.14~0.25mm²
8pin: 26~24AWG/0.14~0.25mm²
- Cable range : 4~6mm
- Wire connection mode: soldering
- Operating temperature: -40°C~+85°C
- RoHS Compliance
- Tolerance : ±0.5mm

PA-M8X-XXP-MM-SL7001-00A(H)

Coding: A,B

Pin number: 03,04,
05,06,08

6pin A Coding

8pin A Coding

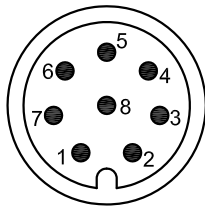
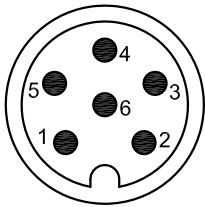

Pin Assignment Front View

Pin Assignment Front View

3pin A Coding

4pin A Coding

5pin B Coding

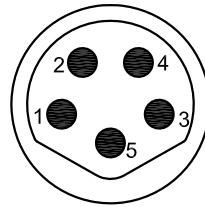
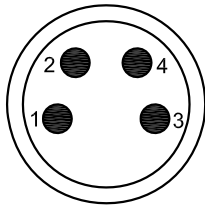
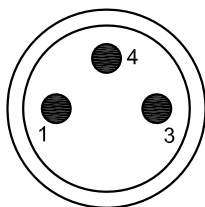

Pin Assignment Front View

Pin Assignment Front View

Pin Assignment Front View

DETACHED LISTS	PART NO.: PAM8XXXPMMSL700100AH	宁波高松电子有限公司 NINGBO DEGSON ELECTRICAL CO., LTD		
	APPD:	NAME: PA-M8X-XXP-MM-SL7001-00A(H)		
	CHKD:	TITLE: CUSTOMER DRAWING		
	DRFT: SQ 2019.05.17	REV: D0-1	SHEET: 1/1	SCALE: 1:1
THIRD ANGLE PROJECTION			DO NOT SCALE DRAWING	